

22W/8857T00

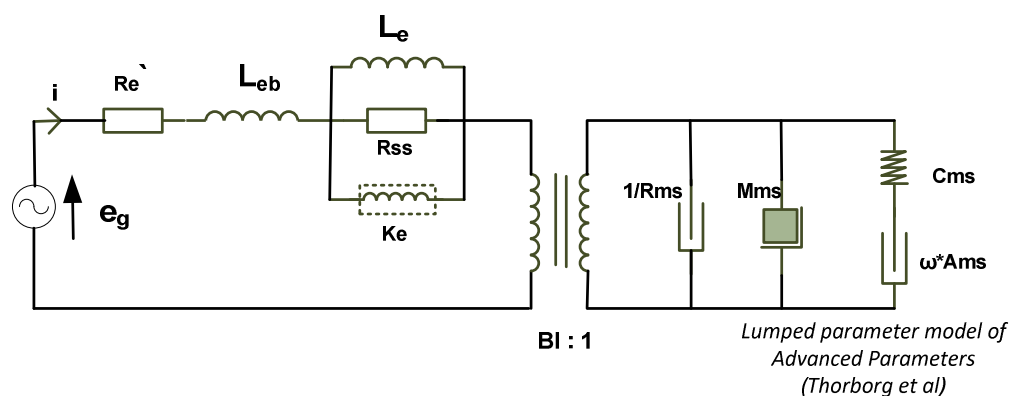

Electrical data

DC resistance ($R_{e'}$)	6.31	[Ω]
Free inductance (L_{eb})	0.180	[mH]
Bound inductance (L_e)	12.8	[mH]
Semi inductance (K_e)	0.0257	SH
Shunt resistance (R_{ss})	30.6	[Ω]

Mechanical data

Force factor (BI)	8.78	[Tm]
Moving mass (M_{ms})	38.4	[g]
Compliance (C_{ms})	0.666	[mm/N]
Admittance (A_{ms})	0.0488	[mm/N]
Mechanical resistance (R_{ms})	0.840	[Ns/m]